

C E R T I F I C A T E



of Conformity
Low Voltage Directive 2006/95/EC

Registration No.: AN 50236007 0001

Report No.: 15055703 001

Holder: Zhejiang Chint Electrics Co., Ltd.
No.1,
Chint Road, Chint Industrial Zone,
North Baixiang
Yueqing, Zhejiang Province 325603
P.R. China

Product: Magnetic Contactor
(Electromechanical Contactor for Household and Similar Purposes)

Identification: Type Designation: NCH8-20/20 NCH8-20/11 NCH8-20/02
NCH8-20/22 NCH8-20/40 NCH8-25/22
NCH8-25/40 NCH8-40/11 NCH8-40/20
NCH8-40/40 NCH8-63/11 NCH8-63/20
NCH8-63/40

Standard : EN 61095: 2009

Serial No. : Engineering sample

Remark: Refer to test report 15055703.001 for details.

This certificate of conformity is based on an evaluation of a sample of the above mentioned product. Technical Report and documentation are at the Licence Holder's disposal. This is to certify that the tested sample is in conformity with all revision of Annex I of Council Directive 2006/95/EC, in its latest amended version, referred to as the Low Voltage Directive. This certificate does not imply assessment of the series-production of the product and does not permit the use of a TÜV Rheinland mark of conformity. The holder of the certificate is authorized to use this certificate in connection with the EC declaration of conformity according to Annex III of the Directive.

Certification Body



Dipl.-Ing. (FH) E. En. He

Date 16.10.2012

TÜV Rheinland LGA Products GmbH - Tillystraße 2 - 90431 Nürnberg

CE The CE marking may be used if all relevant and effective EC Directives are complied with. CE

Report Number: 15055703 001
Model: NCH8-20/... 2 pole



NCH8-20/... 2 pole contactors

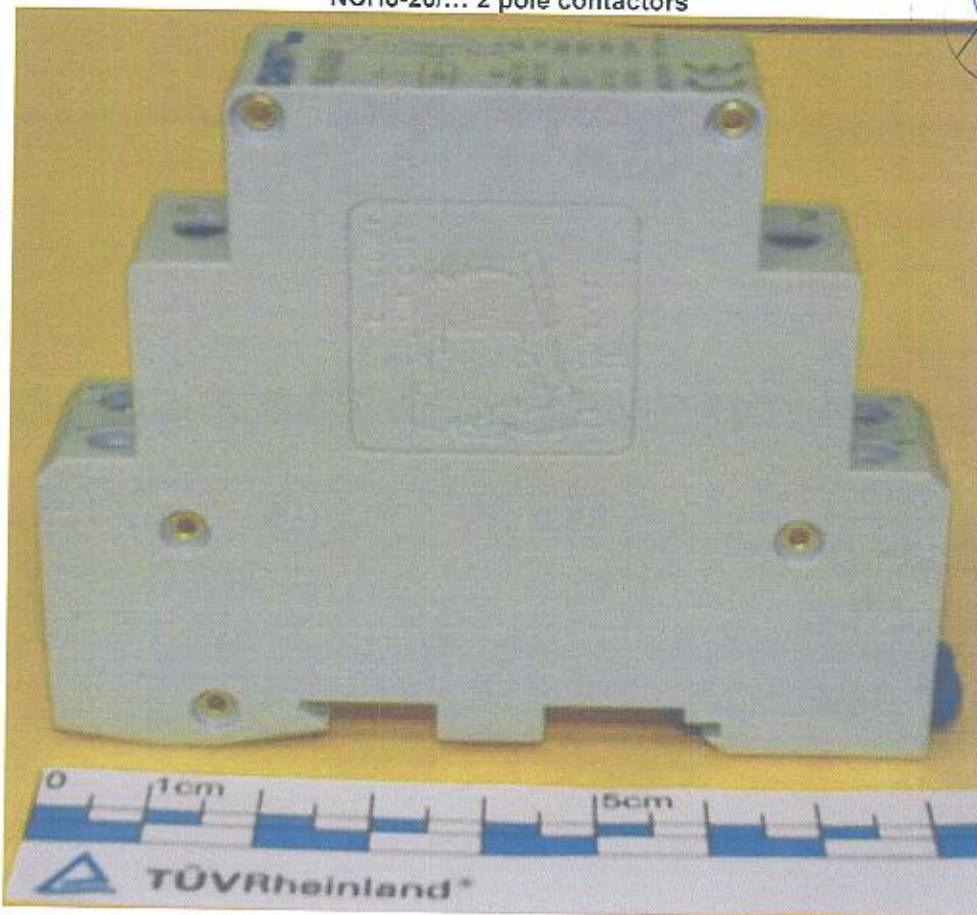

NCH8-20/20

Report Number: 15055703 001
Model: NCH8-20/... 2 pole

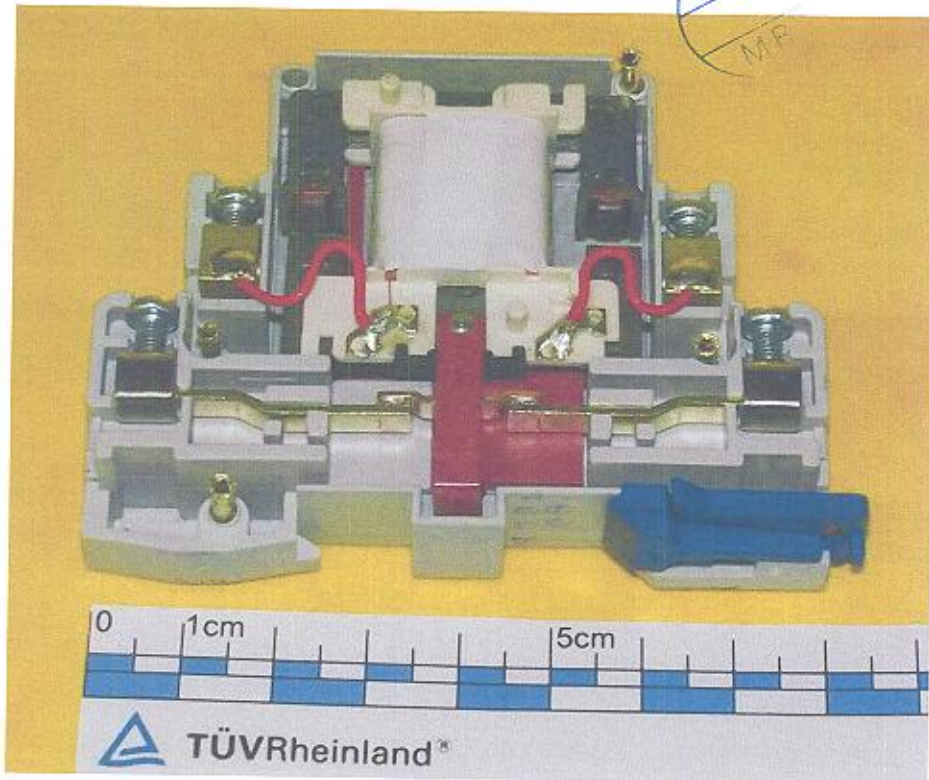
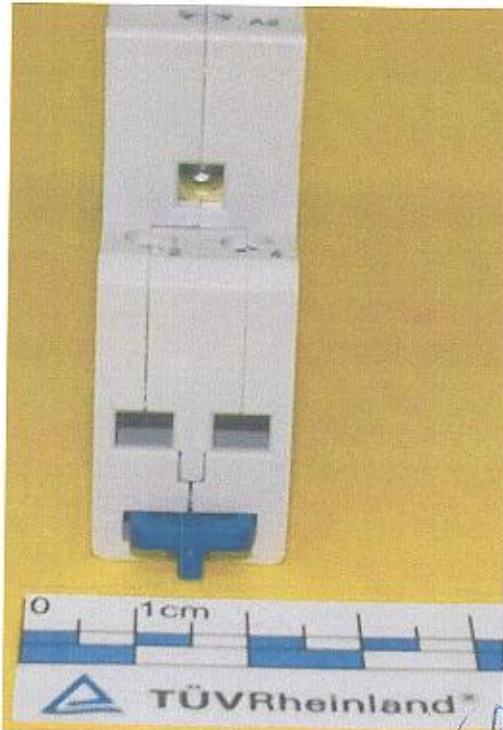

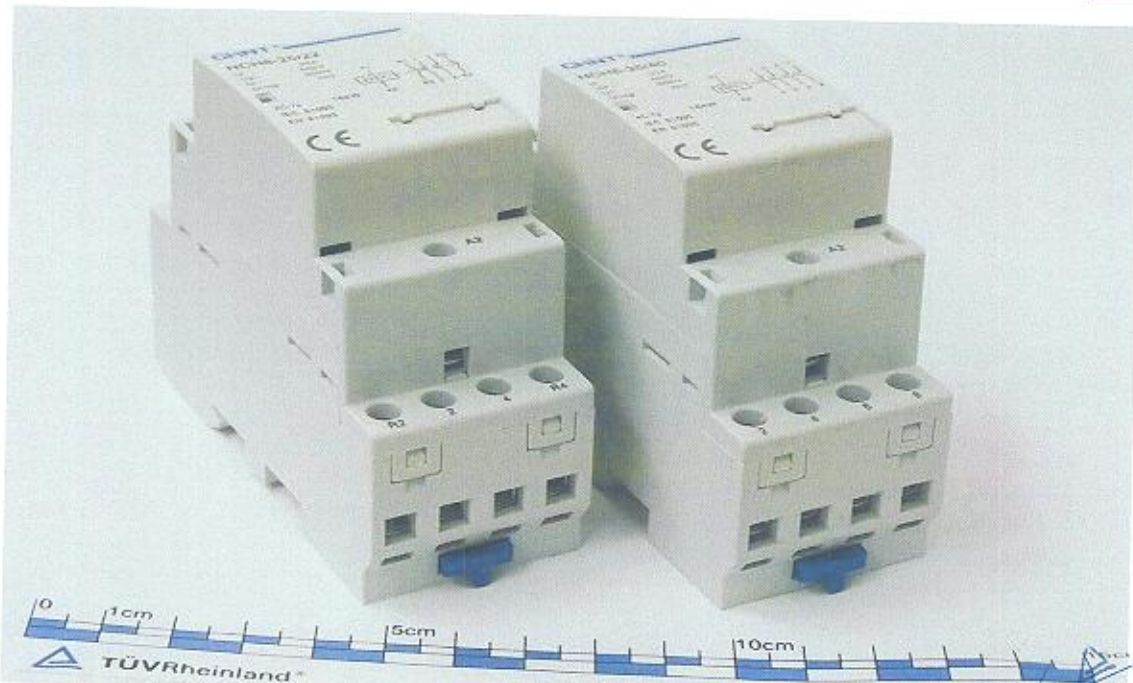

NCH8-25/22 and NCH8-25/40

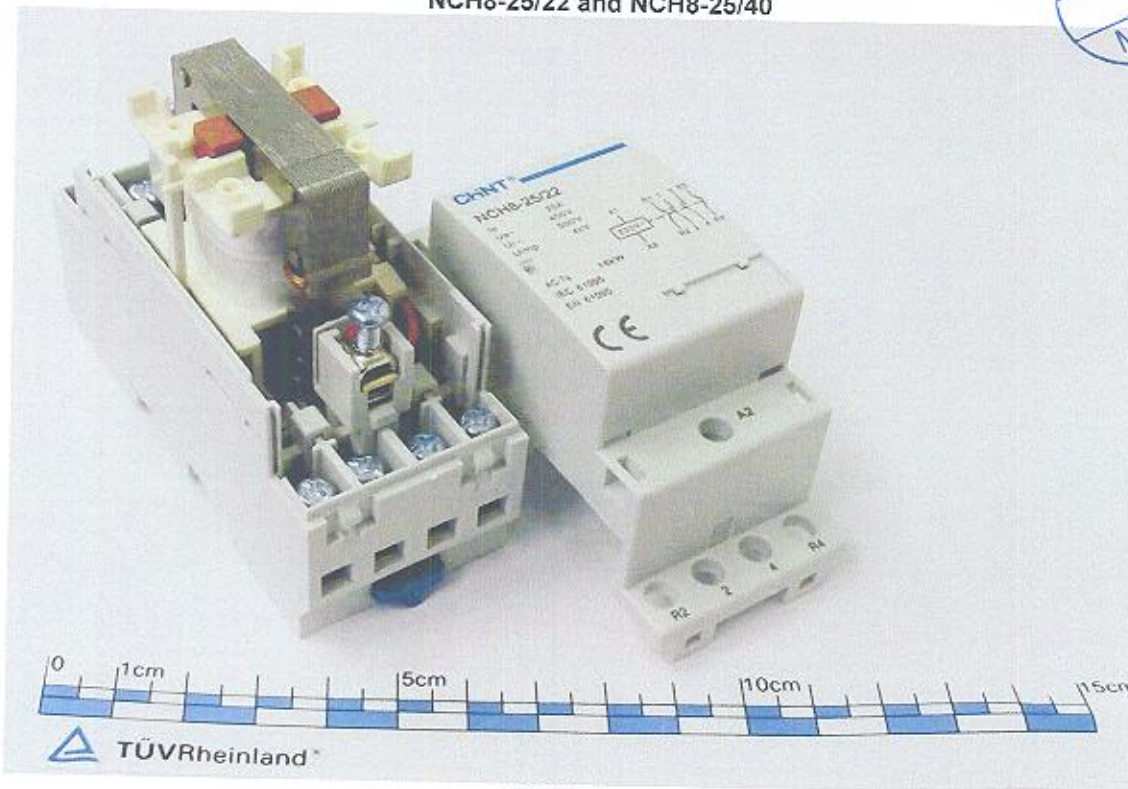

NCH8-25/22

Report Number: 15055703 001

Model: NCH8-40/11, NCH8-40/20 and NCH8-40/40



NCH8-40/11, NCH8-40/20 and NCH8-40/40

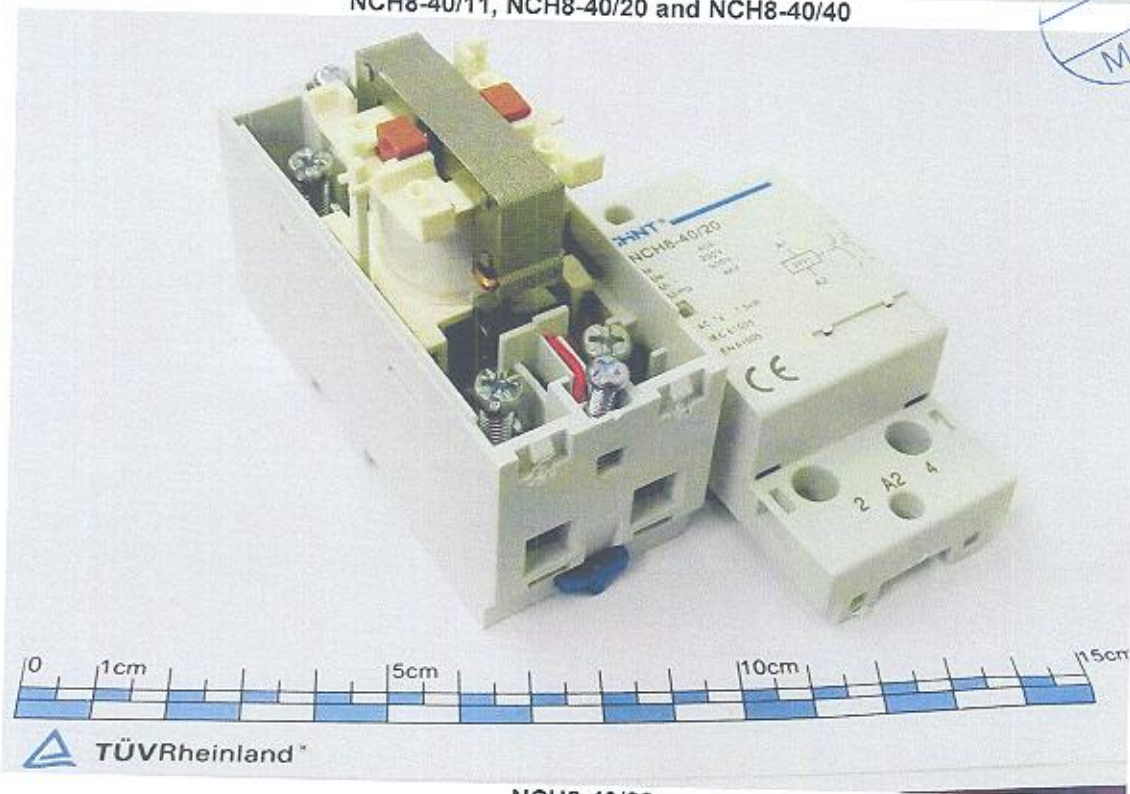

NCH8-40/20

Report Number: 15055703 001

Model: NCH8-40/11, NCH8-40/20 and NCH8-40/40

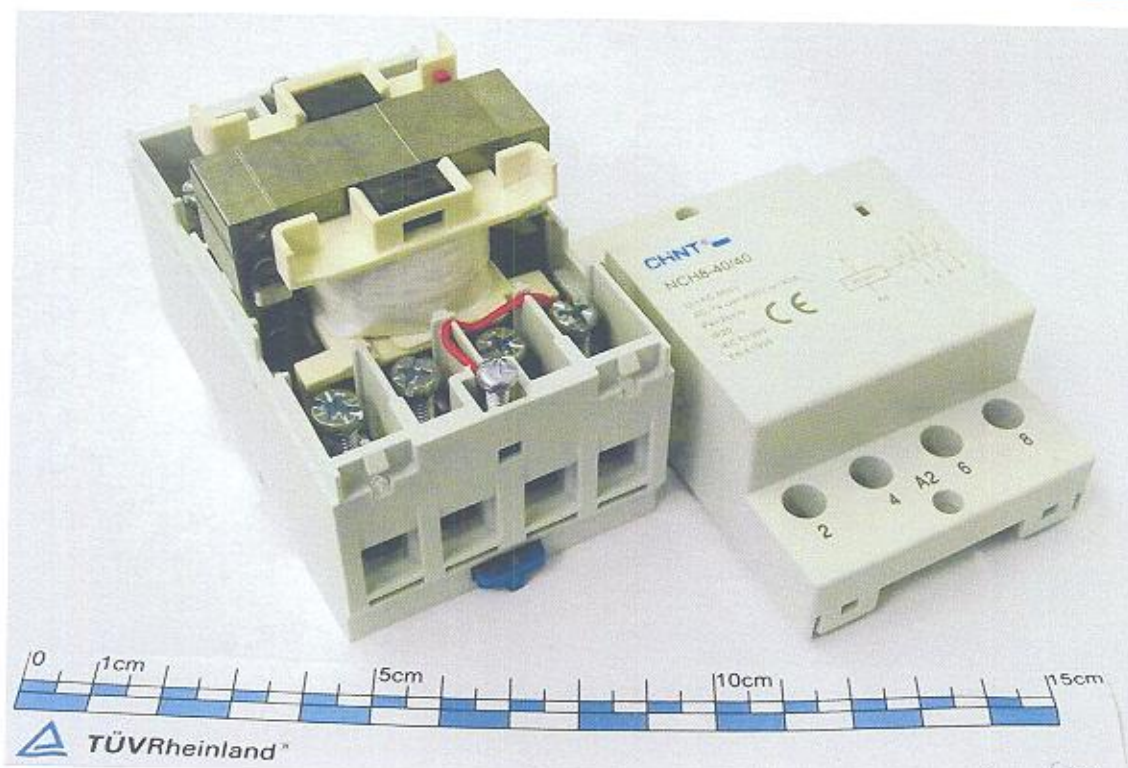

NCH8-40/40



Report Number: 15055703 001

Model: NCH8-63/11, NCH8-63/20 and NCH8-63/40

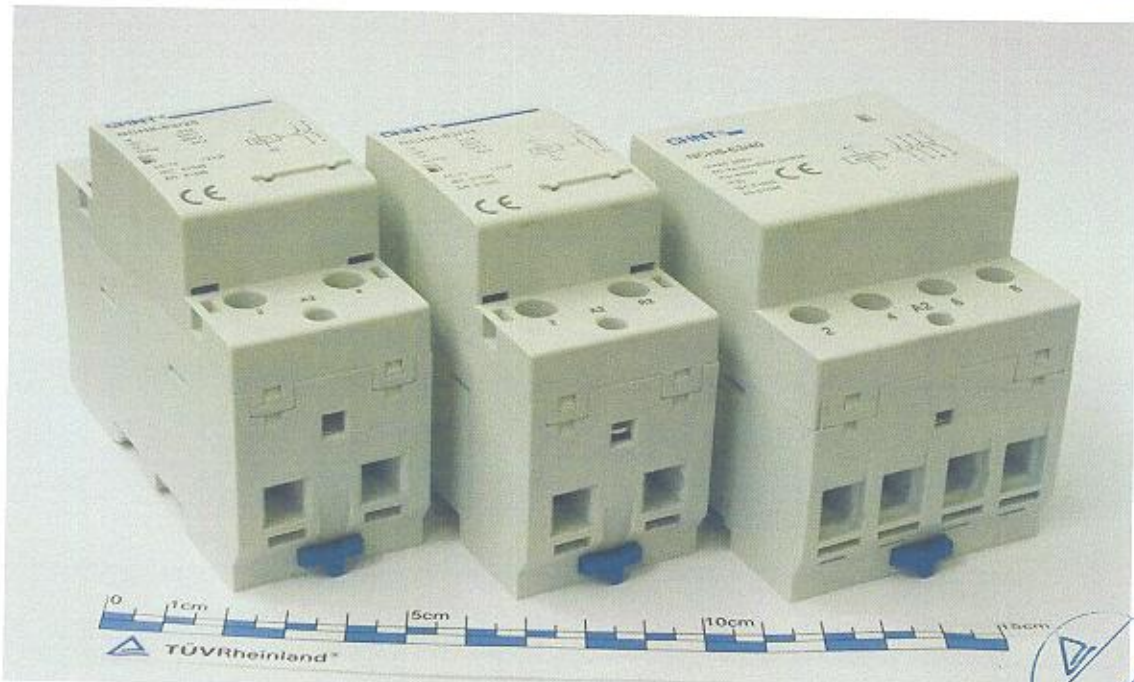

NCH8-63/11, NCH8-63/20 and NCH8-63/40

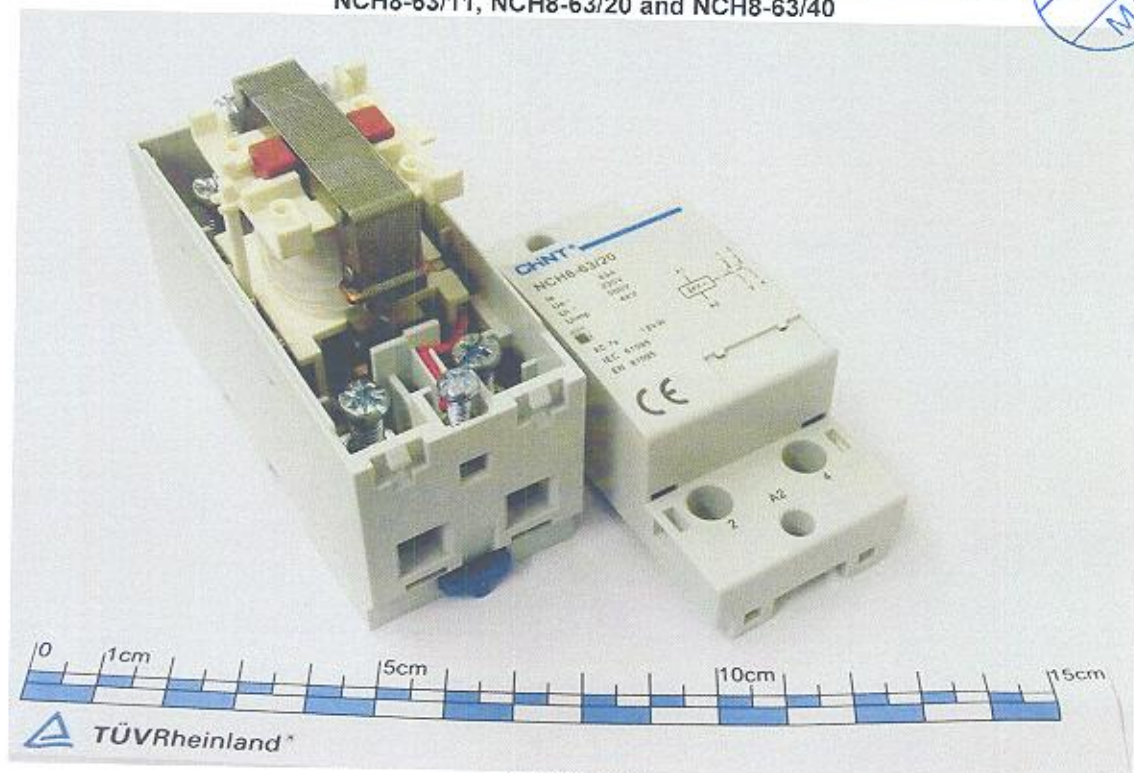

NCH8-63/20

Report Number: 15055703 001

Model: NCH8-63/11, NCH8-63/20 and NCH8-63/40

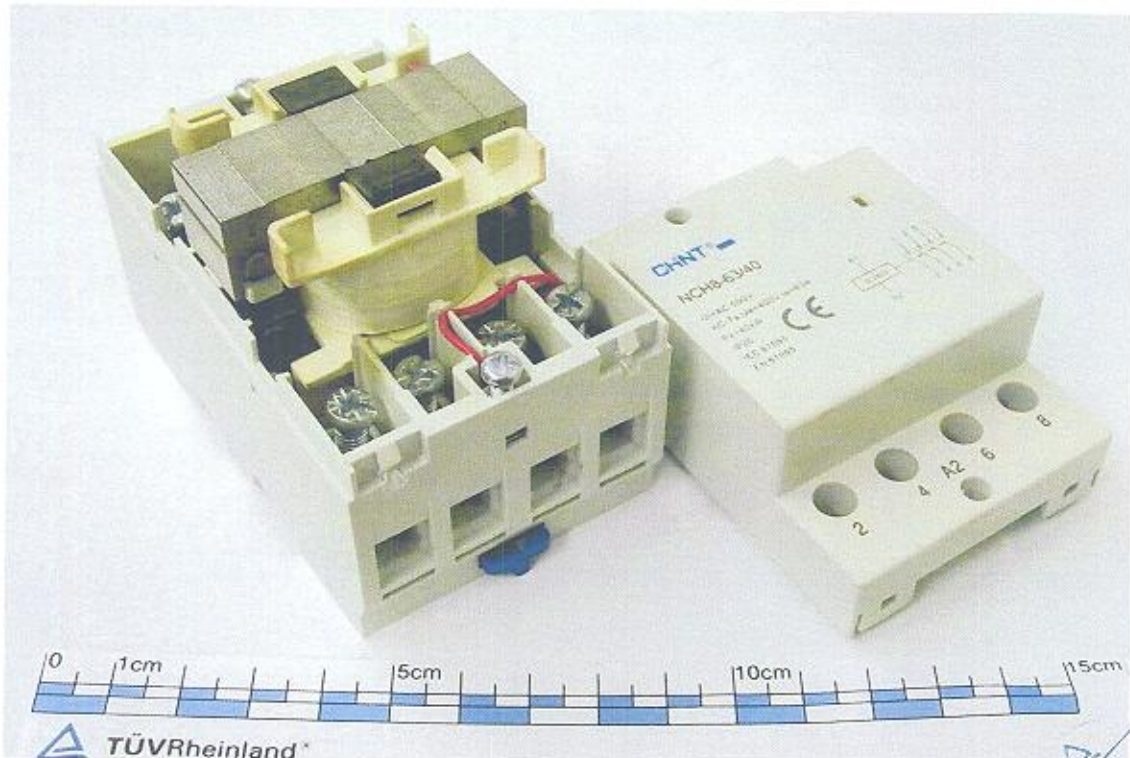

NCH8-63/40

MR

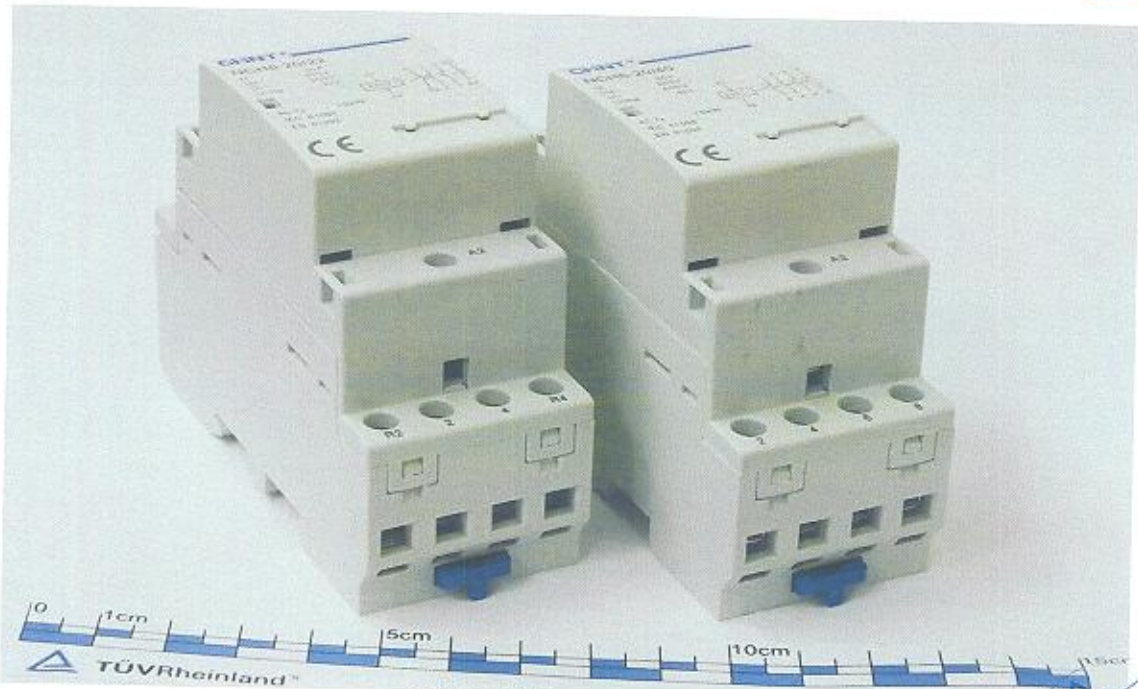

NCH8-20/22 and NCH8-20/40

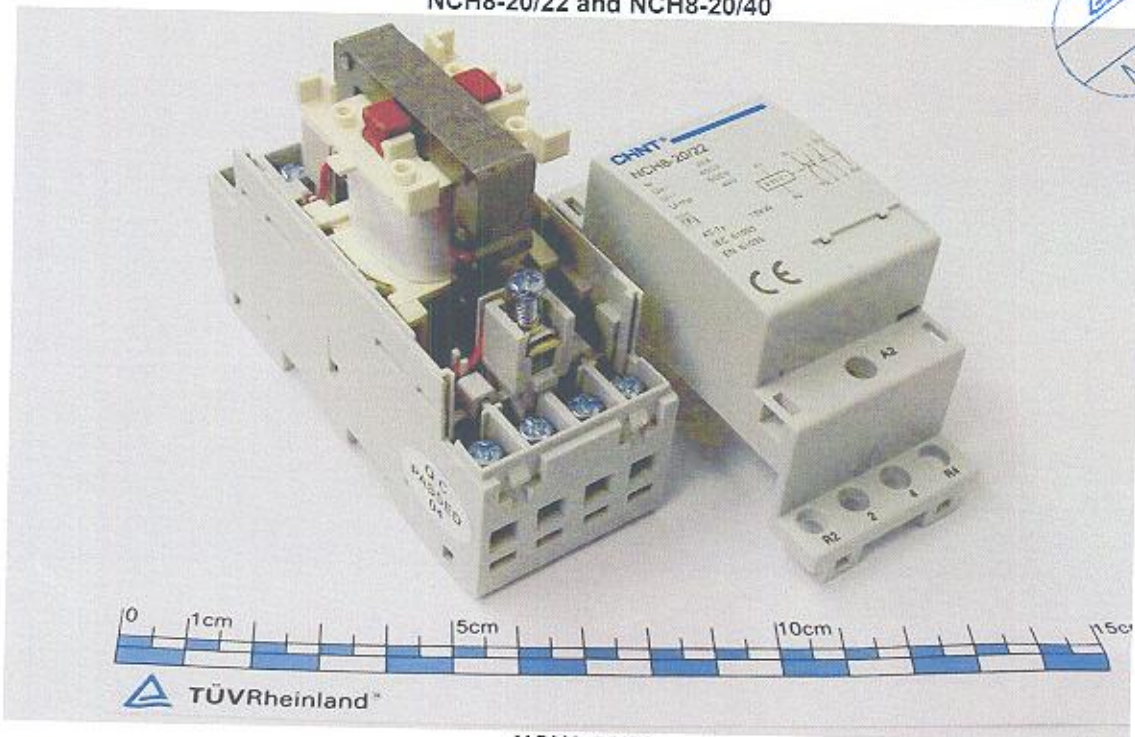

NCH8-20/22

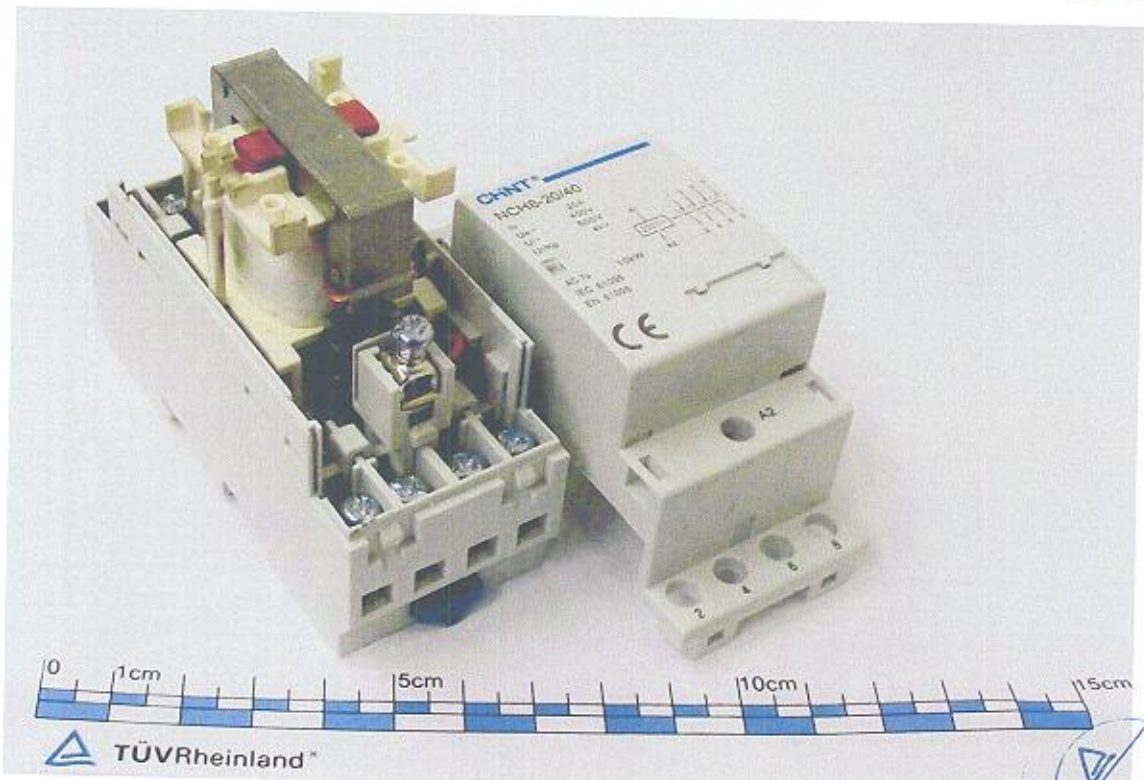

NCH8-20/40



Zhejiang Chint Electrics Co., Ltd.
Huang Qin
-
No.1,
Chint Road, Chint Industrial Zone,
North Baixiang
Yueqing, Zhejiang Province 325603
P.R. China

Date : 16.10.2012
Our ref. : MR 01
Your ref.: H.Q.

Ref : AN Certificate of Conf. Low Voltage D.

Type of Equipment : Electromechanical Contactor for Household and
Similar Purposes
Model Designation : See Certificate
Certificate No. : AN 50236007 0001
Report No. : 15055703 001

Dear Huang Qin,

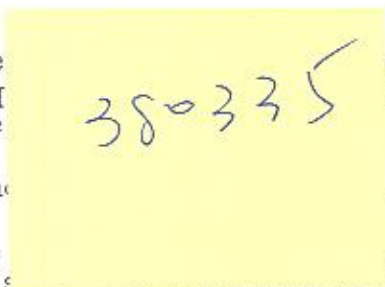
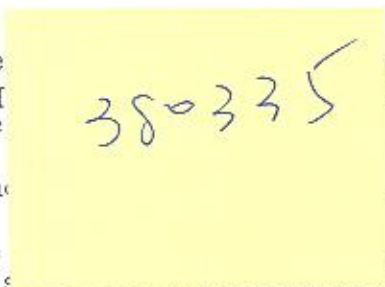
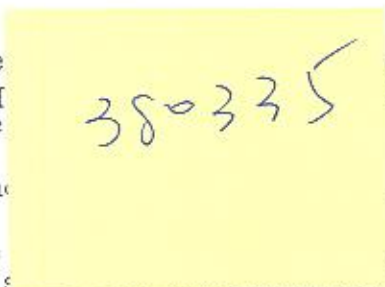
We  at a sample of the above mentioned technical
eq  ted and was found to be in accordance with the
re 

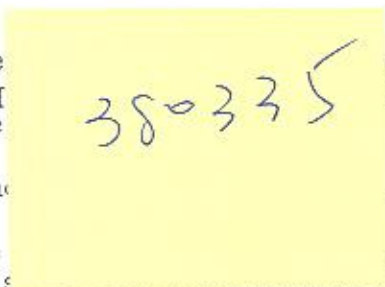
Enc  our Certificate of Conformity.

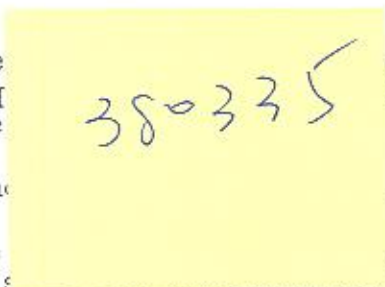
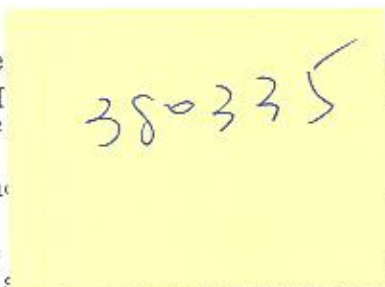
We  d support and would like to offer our
ass  and continuous services in the future.

With kind regards,

Certification Body

Dipl.-Ing. (FH) F. He

CC: Zhejiang Chint Electrics Co., Ltd.

Enclosure

证书的详细资料请登陆 www.tuvdotcom.com 查阅,或拨打我司客服热线 800 999 3668 / 400 883 1300 咨询